

springfree[®] TRAMPOLINE

featuring *tgoma*[®]

Installation and User Guide for Springfree O92 Trampoline

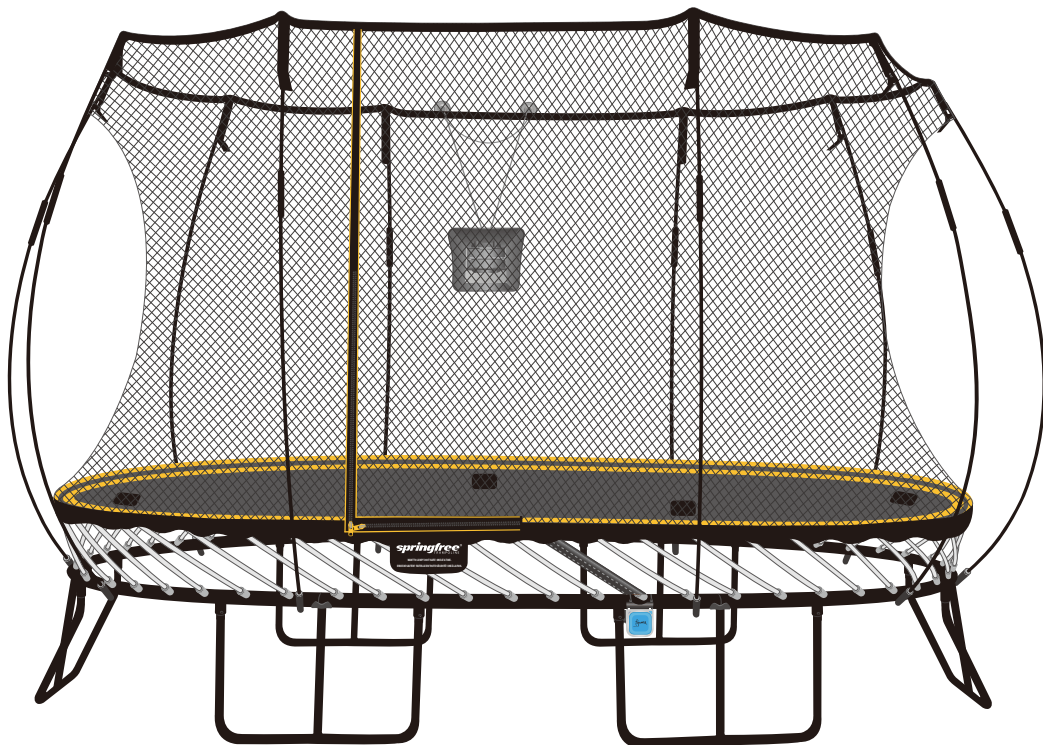

The information in this document is subject to change without notice.

© Copyright tgoma NZ Ltd., 2017. All rights reserved.

729805



WARNING

Please read the Installation and User Guide before using your tgoma® game system and keep it for future reference.



Treat any loaded rod with caution until you are sure it is properly installed or uninstalled. Keep face clear of loaded rods. An improperly installed rod could release and cause facial injury or blindness.



Never attempt to remove a black net rod from its net pocket or disengage (unlock) the rod sleeve while the black net rod is under tension.



The trampoline and tgoma game system are not intended for children under 6 years of age as certain parts could represent a choking or entrapment hazard.



This game system should be disposed of separately from household waste and according to local laws. When disposing of this equipment, please take it to a designated collection point. Incorrect disposal of items can be hazardous to the environment. Many items can be recycled. Follow all local regulations for any disposal. Packaging elements of this product have been labelled to assist your choice of recycling options. In particular, always dispose of the (user supplied) batteries in full accord with the battery manufacturer's instructions.



Installing the tgoma can be challenging if you don't carefully follow these instructions. To make it easier, we have demonstration videos that will guide you through each step. Visit www.tgoma.com/support to get started.



Assembly and disassembly of the trampoline in any way other than what is set out in these instructions could cause serious injury or damage the trampoline.



Do not hold onto, or place fingers between the rods while someone is jumping on the trampoline.



This game system uses sensors to detect your position on the trampoline mat. They read most accurately when the trampoline is installed on a flat, level surface. If your trampoline is installed on a surface that is more than 100mm out of level from one side of the trampoline to another, we recommend that you level the trampoline.



Springfree trampolines are designed and constructed with all-weather parts, however, in regions where there is an accumulation of snow and ice and/or temperatures drop below 14°F (-10°C), we recommend the removal of the tgoma game system controller from the trampoline. The cables do not need to be removed, however, please ensure that the plugs at the end of the cables are tightly sealed in plastic (e.g. inside a plastic bag) and positioned in such a way that no moisture can enter.



WARNING

Please read the Installation and User Guide before using your tgoma® game system and keep it for future reference.

- A. Two people are required for assembly. Installation typically takes two hours to complete.
- B. Keep small children at least 25 ft (7.5 m) away while assembling the trampoline; they could be injured by improperly assembled rods releasing and ejecting from the frame.
- C. Do not attempt to use the trampoline until it is completely assembled.
- D. Be aware that when loaded, the rods can spring back and may cause injury. Keep your face well clear of the rods during assembly or disassembly. An improperly installed rod could release and cause facial injury or blindness.
- E. The sleeves on the rods are intended to provide protection from fibres or splinters. Do not remove. If they are damaged, replace them.
- F. Maintain a minimum clearance of 16.5 ft. (5 m) above the mat [in USA and Canada, 24 ft (7.3 m) above the trampoline from ground level] in order to prevent users from inadvertently contacting overhead hazards such as electric wires, tree limbs or clothesline.
- G. Maintain a minimum clearance of 5 ft (1.5 m) [in EU countries, 6.5 ft (2.0 m)] on all sides of the trampoline. This area should not include concrete, bitumen, brick or other hard surfaces or be in the proximity of other conflicting installations (e.g. pools, swings, slides, climbing frames) as these can cause serious injuries if users fall off the trampoline.
- H. Do not locate the trampoline on top of other objects or store anything underneath the trampoline bed.
- I. Place the trampoline in a well-lit area.
- J. Record the date of purchase on the enclosure label in the space provided.
- K. Only use approved Springfree® Trampoline accessories, and install in accordance to installation instructions. Do not make modifications to the trampoline or accessories.
- L. Secure the trampoline against unauthorized and unsupervised use.
- M. The owner and supervisors of the trampoline are responsible to make all users aware of practices specified in the User Guide.
- N. Trampoline enclosure is supplied as part of the trampoline. Do not install enclosures that are not suited to your product.
- O. The trampoline is intended for indoor/outdoor usage. Refer to Trampoline location information in the User Guide for more details.
- P. Use only with mature, knowledgeable supervision. Enforce all safety rules.
- Q. The cable attachment system utilizes small plastic cable clips. When not installed, keep out of reach of small children as they could represent a choking hazard.
- R. The tgoma game system contains small magnets. Swallowed magnets can stick to intestines causing serious injury or death. Seek immediate medical attention if magnets are swallowed or inhaled.
- S. Ensure adequate supervision of children while inserting and removing the tablet from the tablet clamp. tgoma takes no responsibility for damages to portable electronic devices resulting from incorrect use or negligence.
- T. Trampolines and portable electronic devices were intended for separate purposes. Take extra precautions while jumping on the trampoline with a tgoma game system installed as it may interfere with or cause the jumper to fall awkwardly.
- U. Do not use the mat/bed when it is wet. Do not use the tgoma game system in rainy or wet conditions. The tablet holder is water resistant, however, it is not designed to provide a completely waterproof shade for the tablet. Do not leave your portable electronic device outside in wet weather.
- V. During play with the tgoma game system, keep away from the tablet holder. Serious injury can occur if teeth/face come in contact with the tablet or tablet holder.
- W. When not using the tgoma game system, remove the tablet holder from the enclosure as it represents a potential impact point.
- X. Do not mix alkaline batteries, standard (carbon-zinc) or rechargeable batteries. Do not mix old and new batteries.

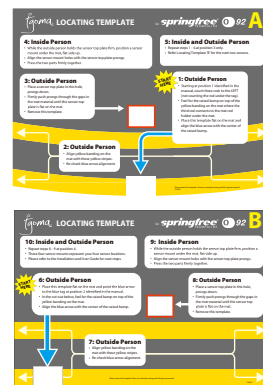
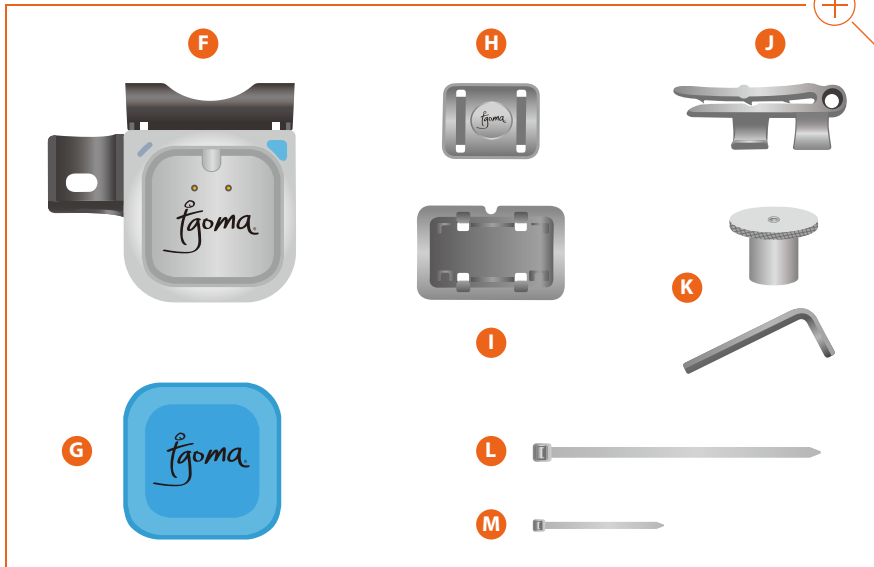
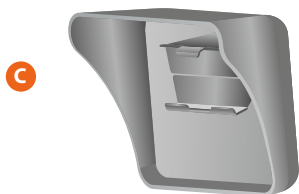
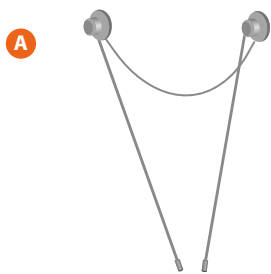

Part	Description	Part	Description		
A	Tablet Holder Rods	1	H	Sensor Top Plate	4
B	Sensor Cables	2	I	Sensor Mount	4
C	Tablet Holder	1	J	Cable Clips	42
D	Sensor Cable Tube	1	K	Nut and Hex Key	1
E	Locating Template	1	L	Large Cable Ties	2
F	Controller	1	M	Small Cable Ties	10
G	Battery Pack	1	N	Spare Small Cable Ties and Cable Clips	8+4



NOTE - TWO people are required for assembly.
NOTE - Installation typically takes ONE hour to complete.

- Layout all parts listed as shown.



TIP - Throughout this manual, certain images contain parts that have been colored orange. This is meant to bring specific attention to a particular installation step and is not a representation of their actual color.



SCAN HERE or visit <http://springfr.ee/install-tgoma> for a helpful installation video.

OUTSIDE VIEW

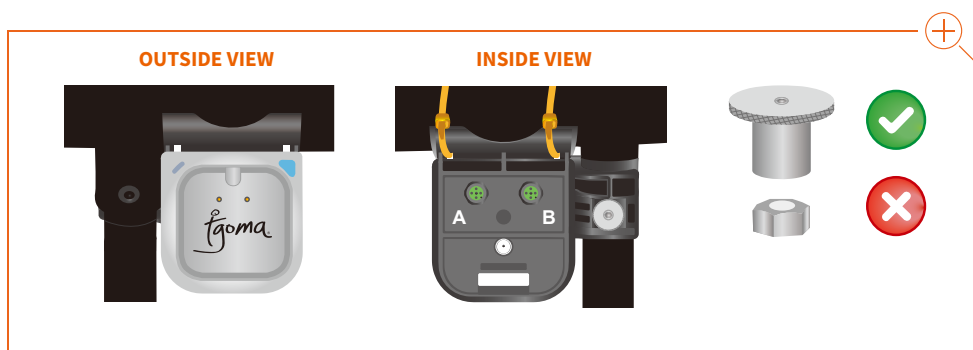
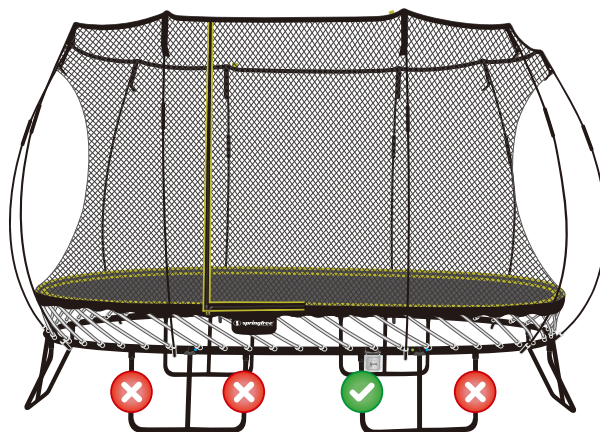

NOTE - Have one person position themselves under the trampoline (hereafter known as the Inside Person) while the other person works around the outside of the trampoline (Outside Person).

NOTE - Be sure to position the controller at the correct leg position, as indicated. If installed in the wrong location, you will be unable to complete the following steps correctly.

- **Inside Person:** Locate the nut on the back of the leg shown above. Remove the nut but DO NOT remove the bolt.
- **Inside Person:** Position the controller as shown and fasten with the new nut provided. Tighten with the hex key.
- **Inside Person:** Feed a large cable tie through each of the two holes and around the frame. Rotate the head of the cable tie so that it is not visible from outside the trampoline, then fasten.



WARNING - Do not remove the bolt from the leg as this could cause serious injury.

WARNING - Do not over tighten the nut. Do not use power driver, torque wrench, or drill.



Check the surface of your mat to see if the sensor plates are preinstalled. If they are, skip to Step 6. You do not need to complete Step 3-5. If the sensor plates are not preinstalled on your mat, please follow the instructions in Step 3.

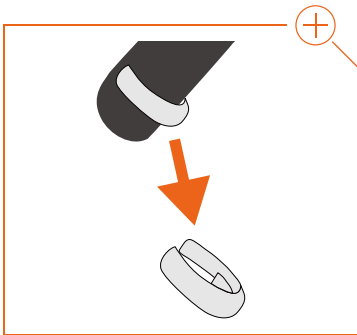
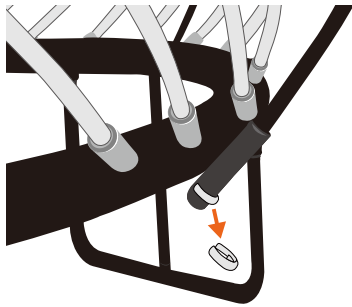

OUTSIDE VIEW

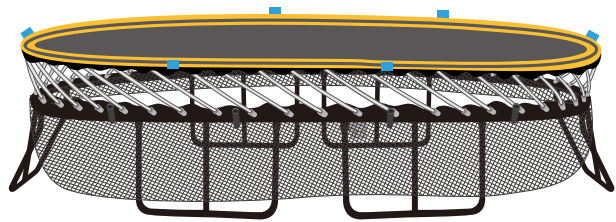
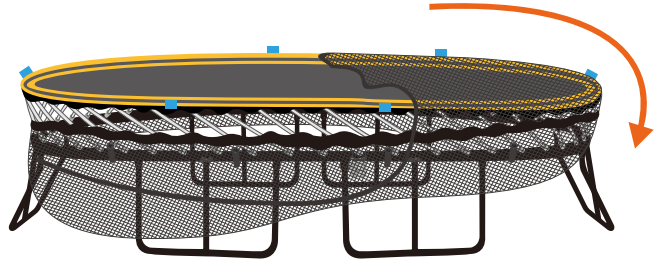

WARNING - Treat any loaded rod with caution until you are sure it is properly installed or uninstalled. Keep your face well away from any loaded rod.

WARNING - Do not use the trampoline unless it is completely assembled. Failure to follow these instructions may cause rods to break or eject from the trampoline frame.

- **Outside Person:** Remove the white c-clips located on the net rod sockets. Lift the bottom end of the black net rods out of the net rod sockets and lower the net.
- **Outside Person:** Remove the black net rods from the net rod pockets.
- **Outside Person:** Starting at a corner, carefully pull the top edge of the net down over the edge of the mat. Continue around the trampoline until the net is sitting at the bottom of the mat rods.

TOP VIEW

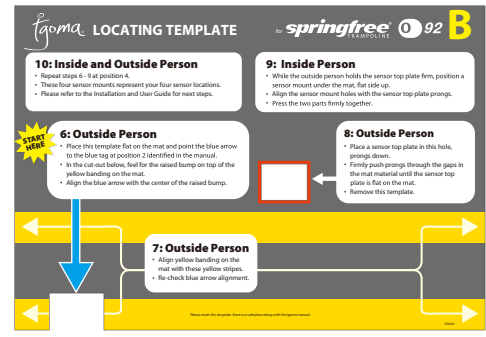
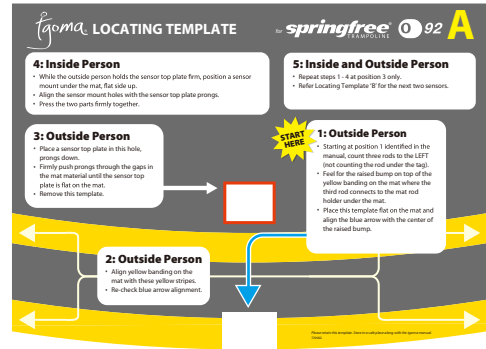
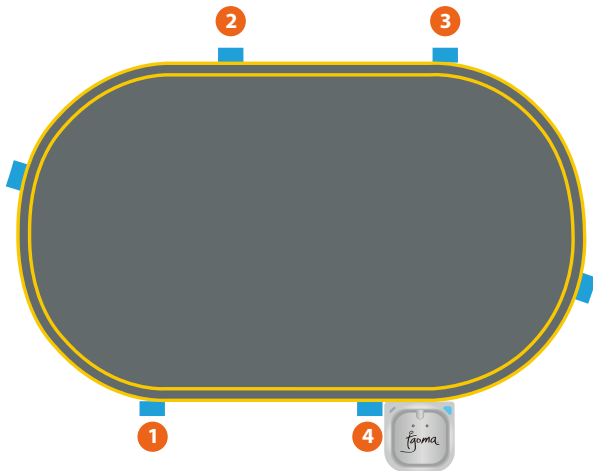

WARNING - Treat any loaded rod with caution until you are sure it is properly installed or uninstalled. Keep your face well away from any loaded rod.

- **Outside Person:** Locate the blue tags on the mat as shown.
- **Inside and Outside Person:** Starting at the first blue tag position shown above, follow the steps on the locating template to install the sensor mounts and top plates. Be sure to start on template A and find the “START HERE” icon for the first step.

BOTTOM VIEW BEFORE

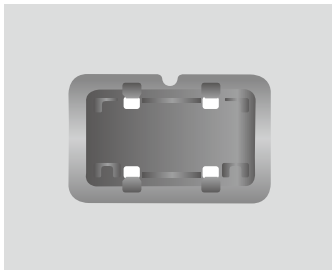

TOP VIEW BEFORE



BOTTOM VIEW AFTER

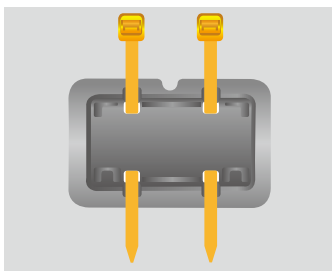

TOP VIEW AFTER



WARNING - Treat any loaded rod with caution until you are sure it is properly installed or uninstalled. Keep your face well away from any loaded rod.



NOTE - Be sure not to fasten the small cable ties during this step.

- **Inside Person:** Feed a small cable tie up through one of the holes in the sensor mount.
- **Outside Person:** Pull the cable tie across the channel and down through the corresponding hole. DO NOT fasten the cable ties, this will be done later.
- **Inside and Outside Person:** Repeat for the other end of the sensor mount and for the remaining three sensor positions.

TOP VIEW

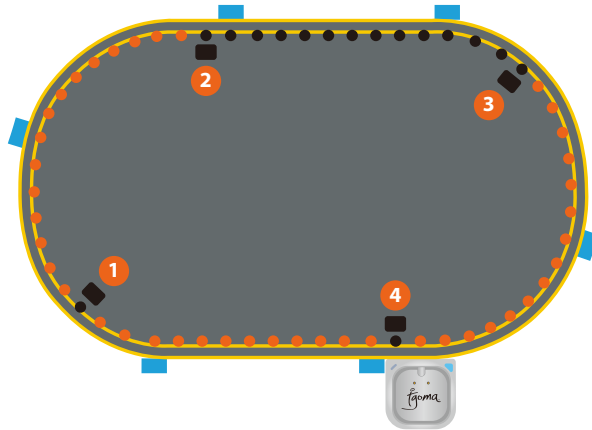

INSIDE VIEW

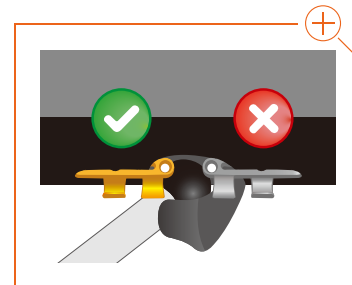
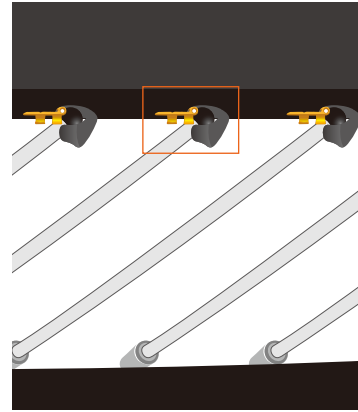

- **Outside Person:** On the surface of your mat, locate the 4 black plastic sensor mounts. These are your 4 sensor positions.
- **Inside Person:** Starting at sensor position 2, locate the first mat rod holder to the le. Install a cable clip at the front of the mat rod holder pocket, as shown.
- **Inside Person:** Moving to the le around the trampoline, install ONE cable clip in front of each mat rod holder pocket between sensor positions 2 and 1. Do not install a cable clip in front of any of the sensor positions.
- **Inside Person:** Repeat this process from sensor positions 1 to 4 and 4 to 3.



NOTE - Before proceeding, double check that each cable clip is pushed fully onto the edge of its pocket and that there are no cable clips installed in front of any of the sensor positions.

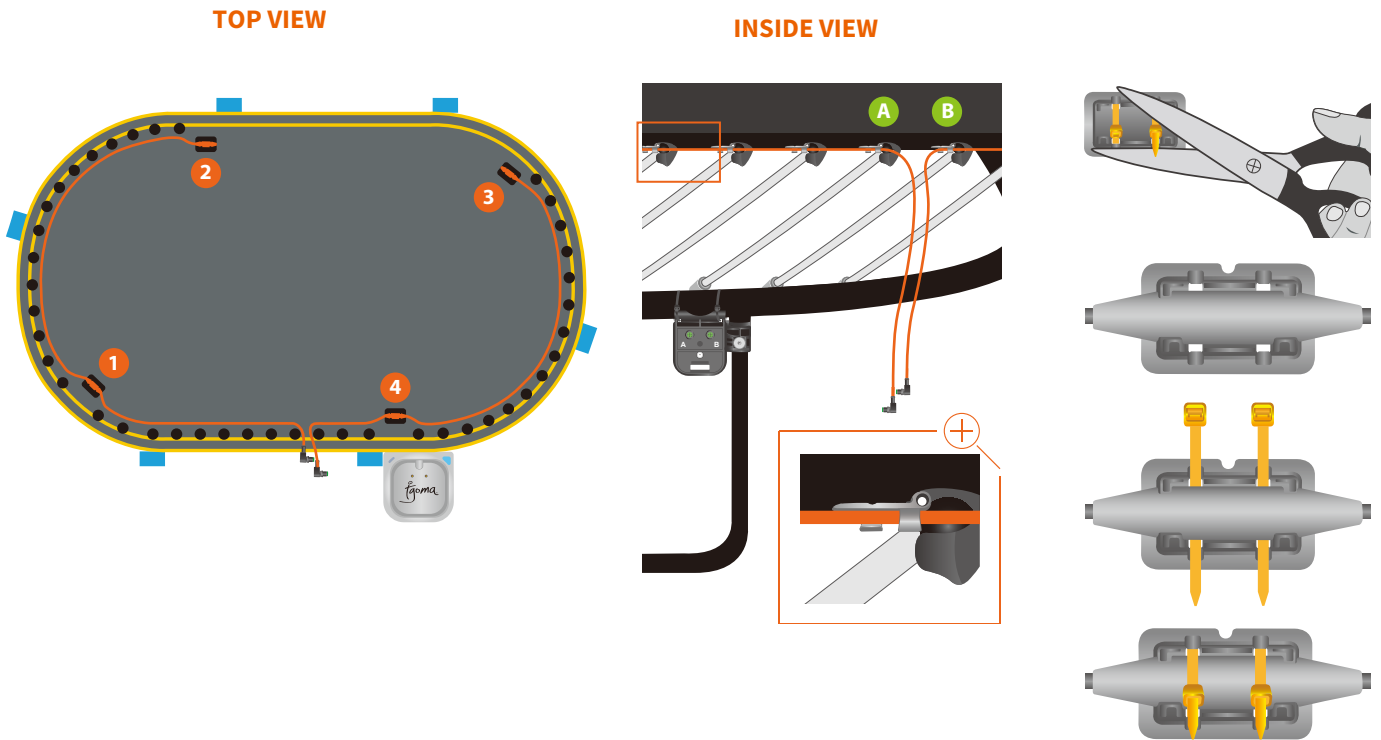

TIP - If you are having trouble inserting the cable sensors into the sensor mounts, try flipping them over. They are designed to only fit one way.

- **Inside Person:** Before installing the cables, note that they are different lengths and have different color labels.
- **Inside Person:** Starting at sensor position 2, carefully cut the cable ties that are currently holding the sensor in place. Take the cable with the WHITE tag and install the end cable sensor into the sensor mount. Once it is in place, fasten with new cable ties as shown.
- **Inside Person:** Then, working towards sensor position 1, install the cable into each cable clip, as shown.
- **Inside Person:** At sensor position 1, install the middle cable sensor into the sensor mount and fasten the cable ties.
- **Inside Person:** Continue installing the cable into the cable clips until you reach position B as shown above. Leave the end of the cable hanging down near the controller.
- **Inside Person:** Starting at sensor position 3, take the cable with the YELLOW tag and repeat the above process to sensor position 4 and then to position A. Be sure to fasten the cable ties at each sensor.

OUTSIDE VIEW

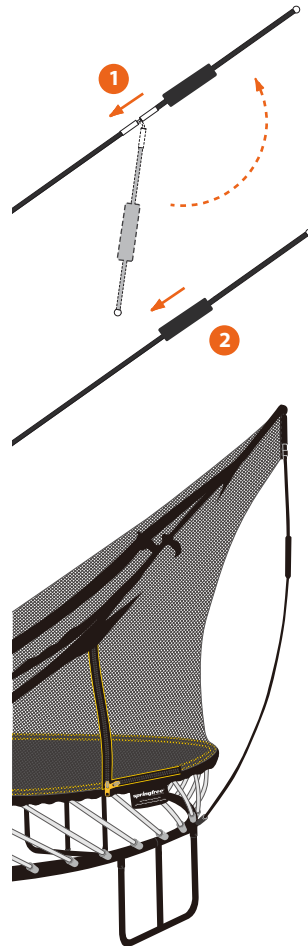
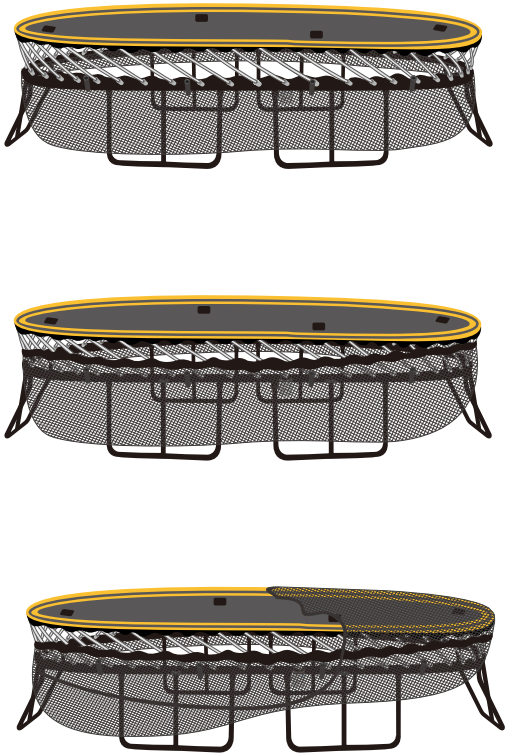

 If your sensor plates were preinstalled, you can skip this step.



WARNING - Treat any loaded rod with caution until you are sure it is properly installed or uninstalled. Keep your face well away from any loaded rod.
WARNING - Never attempt to remove a black net rod from its net rod pocket or disengage (unlock) the rod sleeve while the black net rod is under tension.



NOTE - Refer to step 8, 9, and 10 in the Trampoline & Enclosure Assembly Instructions for more information.

- **Outside Person:** Starting at a corner, carefully pull the net up over the edge of the mat. It is normal for the net to be tight.
- **Outside Person:** Working around the frame, lift the rest of the net into the center of the mat. Ensure that the bottom band of the net is pulled all the way to the top of the white mat rods.
- **Outside Person:** Re-assemble the black net rods as shown.
- **Outside Person:** Insert ALL of the black net rods into the net rod pockets at the top edge of the net. Push the rod up into the pocket and past the catch. You will feel some resistance as the ball is pushed through.
- **Outside Person:** Ensure all of the C-clips are installed and fully seated.
- **Outside Person:** Insert the bottom end of the black net rod into the net rod socket on the trampoline frame. You will hear a click when the black net rod is fully seated.

INSIDE VIEW

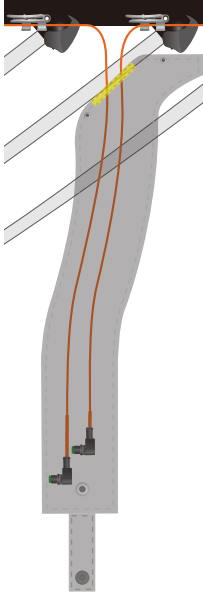

INSIDE VIEW

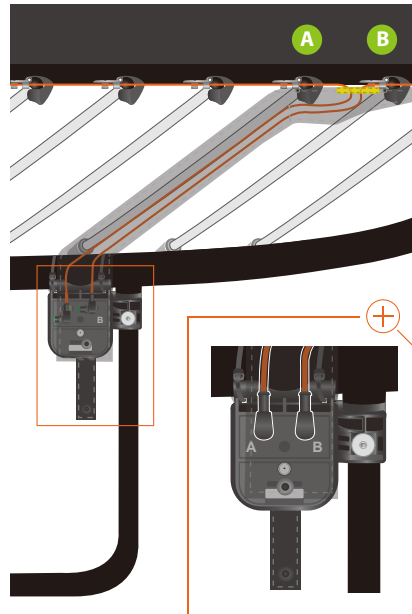

INSIDE VIEW

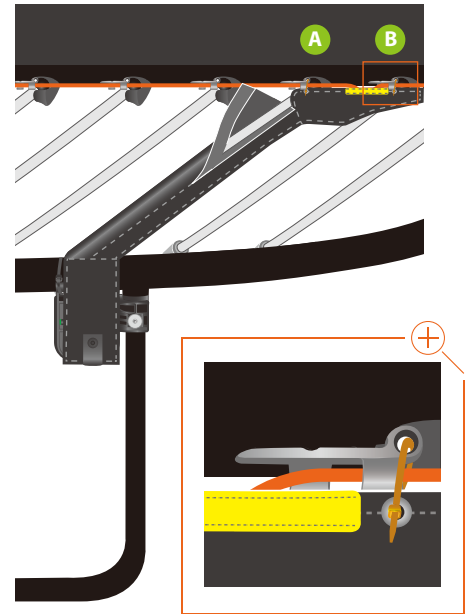

- **Inside Person:** Locate the ends of the cables that are hanging down at cable clip **A** and **B**. Cable **A** should be on the left and cable **B** on the right, as shown.
- **Inside Person:** Next, locate the yellow strip along the top edge of the sensor cable tube. At the yellow strip, feed cable **A** through the top of the tube until it comes out the end.
- **Inside Person:** Repeat with cable **B**. When the end of the cable comes out the end of the tube, plug it into socket **B** on the back of the controller and tighten the collar. Then, plug the end of cable **A** into socket **A** and tighten.



NOTE - Cable **A** must be plugged into socket **A** and cable **B** into socket **B**. The cable plugs and controller sockets are designed to only fit one way. Line up the green post in the cable plug with the slot in the controller socket. Do not force or twist the plug into the socket; when you have correctly aligned them, they will slide together easily.

- **Inside Person:** Undo the Velcro® strip on the sensor cable tube, wrap it around the mat rod, and refasten, as shown.
- **Inside Person:** Next, locate the eyelets along the top edge of the sensor cable tube. Pass a small cable tie through the eyelet and the hole in the cable clip, as shown, then fasten. Repeat for both eyelets.
- **Inside Person:** Fasten the strap at the bottom of the sensor cable tube through the back of the controller.
- The remaining steps can be completed by just one person.



WARNING - If there is any excess cable, loop it and tuck it back up into the sensor cable tube.

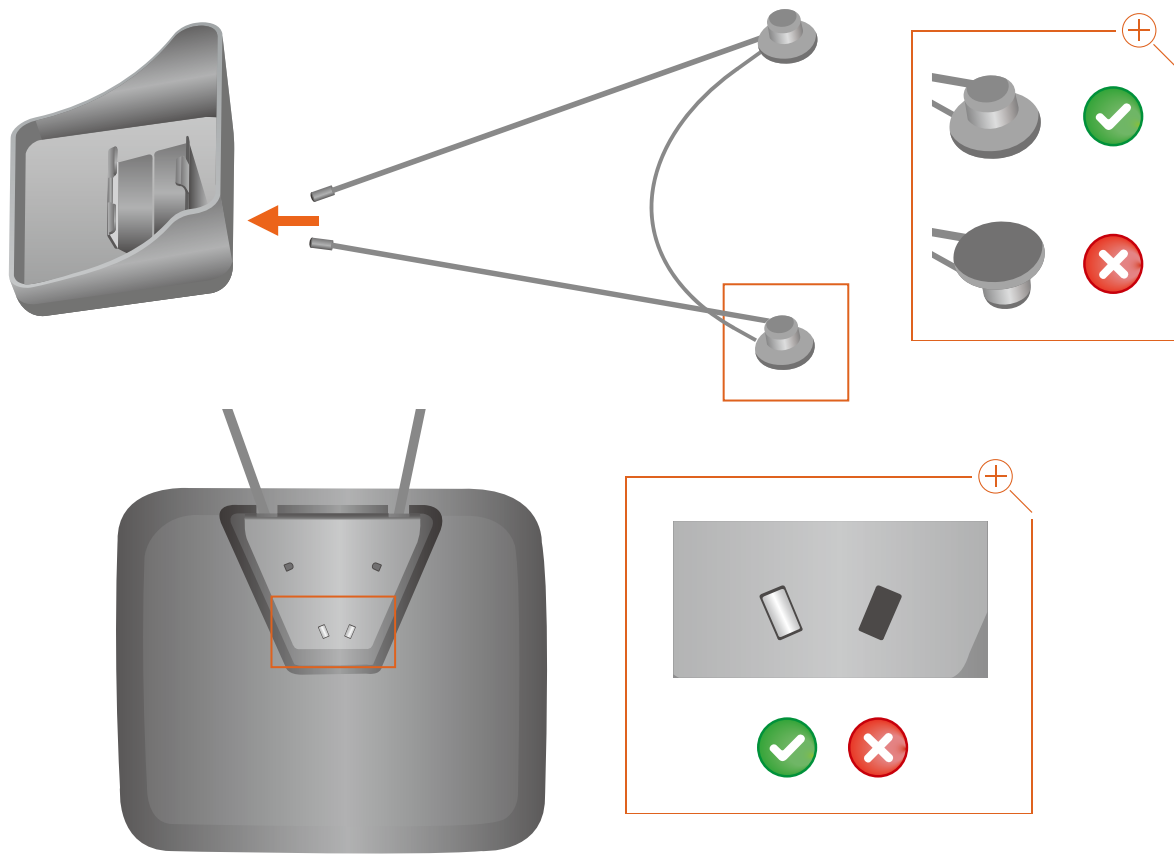

WARNING - Treat any loaded rod with caution until you are sure it is properly installed or uninstalled. Keep your face well away from any loaded rod.



TIP - The software's default position for the tablet holder is opposite the door. Consult your Software User Guide for how to position the tablet holder in alternative locations.
TIP - If you accidentally install the rods with the incorrect orientation, push a key into each slot on the back of the plastic part of the tablet shade and pull the rods free.

- Orient your tablet holder rods relative to the tablet holder, as shown.
- Insert the rods into the back of the tablet holder. When assembled, the rods will click into place. When fully inserted, you should be able to see the ends of the rods through the slots and the rods will not easily come loose.

Minimum Tablet Specifications

We test on Apple and Samsung devices and recommend these brands for tgoma.

Apple® Tablets:

- iPad 3 or newer
- iPad Mini & iPad Air & iPad Pro 9.7"
- Screen size between 7" and 11" (***i.e. tablets, not phones***)

Android™ Tablets:

- Android operating system (4.4 or newer)
- Bluetooth®4.0 (also known as Bluetooth LE or Bluetooth Smart)
- Screen size between 7" and 11" (***i.e. tablets, not phones***)

Tablets Not Supported:

- iPad 1 or 2
- Windows® tablets
- Tablets using Intel Atom (X86 architecture) processors.



NOTE - tgoma software is designed to operate on tablets with the minimum specifications listed above. If you are trying to use tgoma on any device outside of these specs tgoma will not work correctly.

NOTE - We recommend you read the full Software User Guide, which can be downloaded from www.tgoma.com/support.



IMPORTANT - When searching for the tgoma app on iTunes® Store or Google Play™, look for this icon.

- Ensure your tablet is connected to WiFi.
- If using an Apple tablet, go to iTunes Store and search 'tgoma'.
- If using an Android tablet, go to Google Play and search 'tgoma'.
- Follow on-screen instructions to download and install tgoma. The tgoma icon will appear in the tablet's app list. Tap to open.

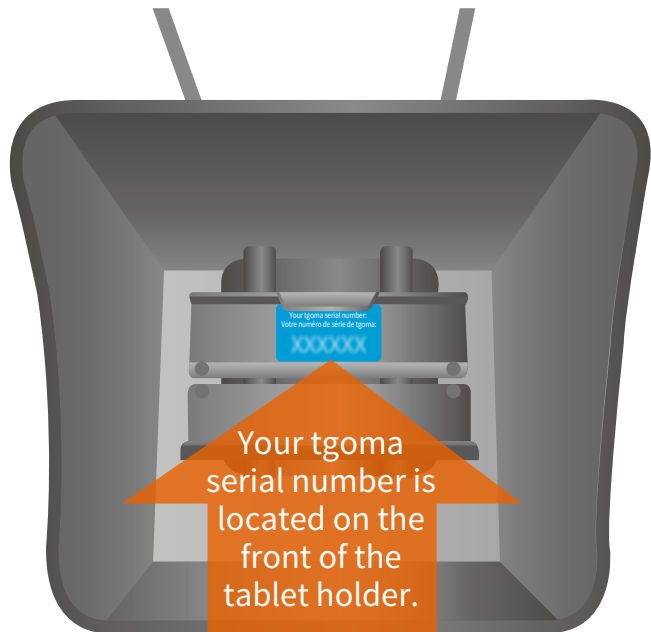

NOTE - Ensure your tablet is connected to WiFi while you are setting it up. Once set up, you do not need a WiFi signal to use tgoma.

NOTE - Ensure you complete all of the Set Up steps. It is important you have selected both the correct trampoline model and position for your tablet (these are steps in the Set Up process).

- Get started with tgoma by setting up your account. Although it is possible to use tgoma as a Guest, to access games and the full range of features tgoma offers, you will need to create a Family Account.
- Use a password you will remember. This will be asked for when downloading new games.
- Enter the serial number from the blue sticker on the front of your tablet holder – this will help our customer care team assist you should you need it.
- Follow the Set-Up steps on-screen.



NOTE - When entering your serial number, do NOT use the serial numbers located on your frames, mats, or nets. Do NOT use your UPC/bar codes. You can only use the serial number from the blue sticker on the front of your tablet holder.

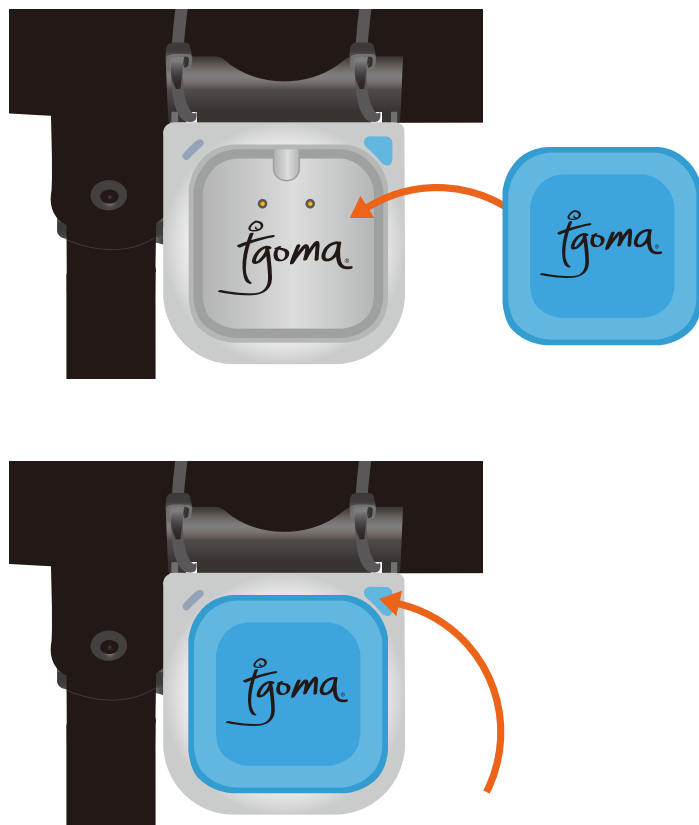

NOTE - When you turn the controller on to connect to your tablet, ensure there is nobody standing on, sitting on, or leaning against the trampoline for 15 seconds. This allows the controller to correctly set the sensors for accuracy.

NOTE - The **RED** light will begin pulsing if there is an error with the system. The error will be described underneath Tech Info on the General Settings page of the tgoma app.



TIP - tgoma is designed to work across a wide range of tablets. Not all versions of Android connect to Bluetooth in the same way. Your tablet should automatically connect to a tgoma controller when you start the tgoma app and turn the controller on. If the **BLUE** light on the controller does not light up after approximately 30 seconds, you may need to power off the tablet and restart it. This should allow the Bluetooth connection to be established.

- Ensure your tablet has Bluetooth turned on. Take the tablet out to your trampoline.
- Install 4 AA batteries into the battery pack and place the battery pack on the controller.
- Make sure nobody is on or leaning against the trampoline.
- Turn on the controller by pressing the button on the front and wait for it to connect to your tablet.
- The **GREEN** light should now be pulsing, indicating that the controller is running. Please wait for at least 15 seconds to allow the system to calibrate the sensors before touching the trampoline.
- Start the tgoma app on your tablet. After a few seconds the **BLUE** light should begin pulsing, indicating that the Bluetooth connection is established.

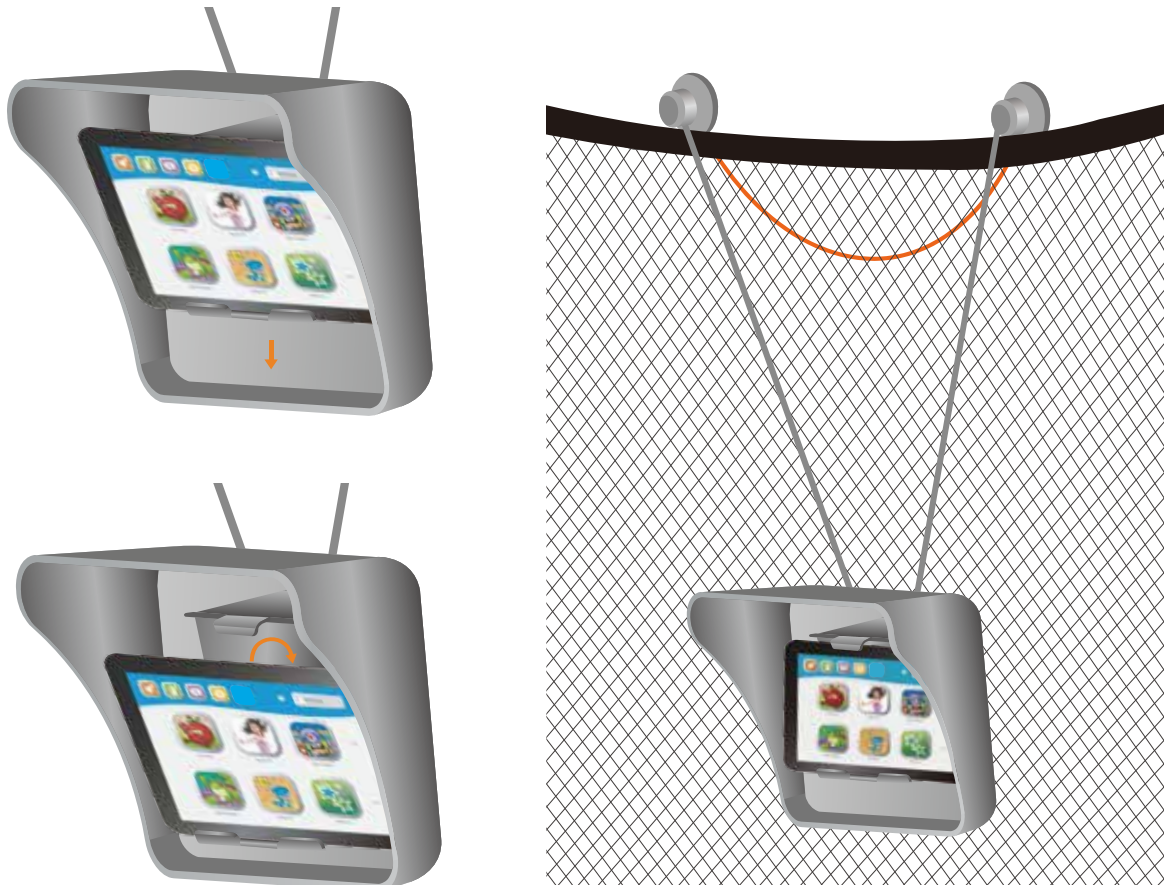

WARNING - Do not leave your tablet outside in wet weather.

WARNING - To protect the batteries store the battery pack indoors when not in use.

- Once you have completed setting up your tgoma on your tablet, hold your tablet in a landscape orientation and place the bottom edge onto the bottom jaw of the clamp.
- Pull the tablet down on the bottom jaw until the clamp opens wide enough for the tablet to fit between the top and bottom jaws of the clamp.
- Push the tablet back into position, and release.
- Hook the tablet holder onto the inside of the trampoline net, opposite the entrance. The curved horizontal rod should be on the outside of the enclosure. If the sun is too bright on your tablet screen, reposition your tablet holder 90 degrees to the left or right of the entrance. Remember to reset your tablet position (in Settings section of the tgoma app) if you move its position.



Games: where your games and apps live once you've downloaded them.



JumpFit: where you access your jump stats via the JumpTracker, or set goals to achieve.



News & Events: where you see news and events to participate in.



Settings: where you set up tgoma (make sure you select your trampoline model in General Settings before using it).



Users: tap this to create a new user. Accurately setting the user weight will allow tgoma to more accurately calculate your energy burn rate. Once users are set up they can compete in competitions and events, and track their activity in the JumpTracker.



NOTE - If you are experiencing any issues, or if you have any questions regarding the installation or performance of your tgoma gaming system, please go to www.tgoma.com/support.

NOTE - When the tgoma controller is powered on it will broadcast its availability to any tablets within an approximate range of 160 ft (50 m). Any tablet running the tgoma application can connect to the controller. Where multiple tablets have the tgoma app installed, close the tgoma app on all tablets except the one being used on the trampoline. This will stop unintended Bluetooth connections occurring.

- Explore tgoma by tapping through the buttons in the menu bar shown above.
- Congratulations! You have successfully installed your trampoline and tgoma game system! Happy bouncing!



This game system should be disposed of separately from household waste and according to local laws. When disposing of this equipment, please take it to a designated collection point. Incorrect disposal of items can be hazardous to the environment. Many items can be recycled. Follow all local regulations for any disposal. Packaging elements of this product have been labelled to assist your choice of recycling options. In particular, always dispose of the (user supplied) batteries in full accord with the battery manufacturer's instructions.

The controller and battery pack attach with powerful magnets. Keep away from electronic devices and magnetic strips to avoid damaging effects.



Product Specifications

- **Name of product as described in the marketing literature:** tgoma Game System.
- **Part number(s):** TGR54000, TGR79000, TGR132000, TGO77000, TGO92000, TGS113000, TGS155000.
- **Operating temperature range:** +32°F to +104°F (0°C to +40°C).
- **Storage temperature range:** +32°F to +104°F (0°C to +40°C).
- **Operating humidity:** 10% to 90% non-condensing.
- **RF compliances:** FCC class B; IC class B; EN/CE class B.
- **Safety agency approvals:** TBD but UL60950 etc.
- **Power:** 4 x user supplied AA (alkaline preferred) batteries. Max voltage = 4 x 1.5V.
- The tgoma game controller and sensor cables are UL listed under file E481698.
- tgoma is a registered trademark of tgoma NZ Ltd.
- The Bluetooth® word, trademark and logos are owned by the Bluetooth SIG, Inc. and any use of such marks is under license. Android™, Google Play™ and the Google Play logo are trademarks of Google Inc. Apple iTunes® and iPad™ are registered trademarks of Apple Inc. Other trademarks and trade names are those of their respective owners.
- Patents pending.
- All rights reserved. No part of this publication may be reproduced, stored in a retrieval system, or transmitted, in any form or by any means, without the prior written permission from tgoma NZ Ltd.
- tgoma NZ Ltd reserves the right to make changes at any time without notification. While every care has been exercised in compiling and publishing the information contained in these pages, tgoma NZ Ltd accepts no responsibility for errors or omissions to the information.

FCC RF Radiation Exposure Statement:

Contains Transmitter Module FCC ID: QOQBLE113

This equipment complies with part 15 of the FCC radiation exposure limits set forth for an uncontrolled environment. End users must follow the specific operating instructions for satisfying RF exposure compliance. This transmitter meets both portable and mobile limits as demonstrated in the RF Exposure Analysis. This transmitter must not be co-located or operating in conjunction with any other antenna or transmitter except in accordance with FCC multi-transmitter product procedures.

IC Statements:

Contains Transmitter Module IC: 5123A-BGTBLE113

This ISM device complies with Canadian ICES-001.

This device complies with Industry Canada license-exempt RSS standard(s). Operation is subject to the following two conditions: (1) this device may not cause interference, and (2) this device must accept any interference, including interference that may cause undesired operation of the device.

tgoma® Game System Limited Warranty

DO NOT USE YOUR PRODUCT UNTIL YOU HAVE READ THE TERMS OF THE WARRANTY. IF YOU DO NOT AGREE TO THE TERMS OF THE WARRANTY, DO NOT USE THE PRODUCT AND RETURN IT WITHIN 7 DAYS TO THE STORE OR THE AUTHORIZED DISTRIBUTOR WHERE YOU PURCHASED IT FOR A REFUND.

WHAT IS COVERED

tgoma NZ Ltd. and its authorized service partners warrant this product against original defects in material and workmanship for a period of ONE (1) YEAR. The warranty period begins from the date of purchase (proof of purchase required). This warranty is only valid when used for private household purposes in accordance with the tgoma® Assembly Instructions. This warranty provides, at no extra cost to you, all parts necessary to ensure your accessory is in proper working condition throughout the warranty period. For information related to the warranty and tgoma software, check www.springfree.com/tgoma.

WHAT IS NOT COVERED

This warranty is subject to the following terms:

- tgoma NZ Ltd. shall not be liable for costs, damages or repairs incurred as a result of:
 - Product purchased from an unauthorized distributor.
 - Improper installation not in accordance with the provided tgoma Assembly Instructions.
 - Careless operation or handling, accident, abuse, misuse and/or lack of maintenance not in accordance with the tgoma Assembly Instructions.
 - External sources such as weather, theft, fire damage, cuts or vandalism.
 - Damage caused by repairs carried out by unauthorized parties or agents.
 - Damage resulting from opening the controller box and tampering with the hardware.
 - Use other than for private household purposes. For example, for commercial or rental purposes.
- This warranty does not apply to consumable parts, such as batteries or protective coatings that are designed to diminish over time, unless failure has occurred due to a defect in materials or workmanship.
- This warranty does not apply to cosmetic damage or minor imperfections that meet design specifications or do not materially alter functionality.
- This warranty does not cover expenses related to on-site labor, travel, assembly or disassembly or other charges associated with the repair or replacement of covered components.
- This warranty does not apply to any non-tgoma products or any software.

SUBMITTING YOUR WARRANTY CLAIM

If you believe your product has a manufacturing fault or a product defect and you need to make a warranty claim, locate and contact your nearest tgoma customer service center at www.tgoma.com/support. Alternatively, you can lodge your warranty claim online at <http://springfr.ee/wclaim>.

The terms of the warranty require that you contact tgoma NZ Ltd. with your model name, serial number, date and place of purchase and a scan of your purchase receipt. Shipping costs associated with approved warranty claims lodged within 45 days from the date of purchase will be covered by tgoma NZ Ltd. Beyond this 45-day period, all shipping costs are the responsibility of the customer. Replacement parts provided under this warranty do not extend the period of the warranty.

WARRANTY LIMITATIONS

- tgoma NZ Ltd. is not responsible or liable for indirect, special or consequential damages arising out of or in connection with the use or performance of the product or any other damages with respect to any economic loss, loss of property, loss of revenue or profits, loss of enjoyment or use, cost of removal, installation, disassembly or other consequential damages. This limitation is not allowed by some states, provinces or territories and so this limitation may not apply to you.
- tgoma NZ Ltd. will not be liable for any consequential damages or incidental damages you may incur in connection with the tgoma game system, any portable electronic devices (tablet, phone, etc.) or trampoline or accessories. This limitation is not allowed by some states, provinces, or territories and so this limitation may not apply to you.
- Any implied warranties relating to your product, including but not limited to warranty of merchantability or warranty of fitness for a particular purpose, are to the duration of this warranty. This limitation is not allowed by some states, provinces or territories and so this limitation may not apply to you.
- This warranty gives you specific legal rights. You may also have other rights which vary by state, province or territory.
- For customers in Australia, our goods come with guarantees that cannot be excluded under the Australian Consumer Law. You are entitled to a replacement or refund for a major failure and compensation for any other reasonably foreseeable loss or damage. You are also entitled to have the goods repaired or replaced if the goods fail to be of acceptable quality and the failure does not amount to a major failure.
- This warranty is not transferable and applies only to the consumer who originally purchased the accessory.
- This warranty does not extend to any portable electronic devices (tablet, phone, etc.) or trampoline or accessories.

If you have any questions or concerns regarding this warranty, locate and contact your nearest tgoma customer service center at www.tgoma.com/support. If you need replacement parts but your warranty has expired, you can purchase them by contacting your nearest tgoma customer service center.