

Assembly and Disassembly Instructions for Trampoline and Enclosure

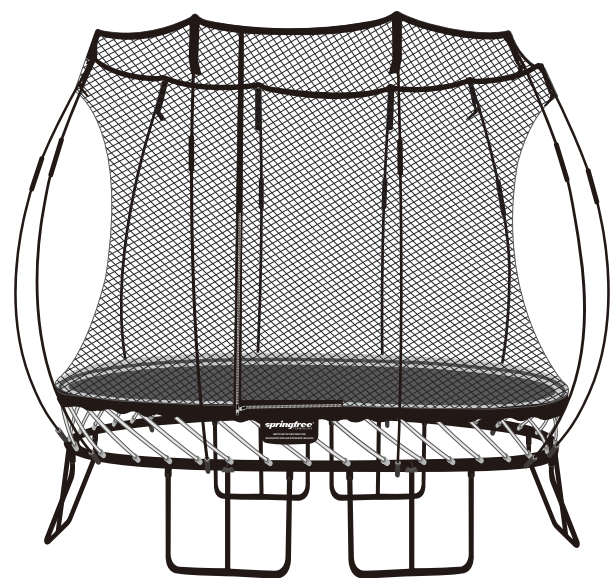

MAT DIAMETER	MINIMUM NET HEIGHT FROM MAT	MAT HEIGHT FROM GROUND	MAXIMUM USER WEIGHT
6 ft x 9 ft (1.9 m x 2.7 m)	5 ft (1.5 m)	2.6 ft (0.8 m)	175 lbs (80 kg)

The information in this document is subject to change without notice. © Copyright Springfree® Trampoline Inc. 2005, 2021. All rights reserved. 762305

★ IMPORTANT

Easy step-by-step 3D interactive instructions for this product can be found in

BILT.®



DOWNLOAD THE FREE APP



⚠ WARNING

Read the warnings on this page and those contained in the User Guide before you assemble and use the trampoline and enclosure.



Treat any loaded rod with caution until you are sure it is properly installed or uninstalled. Keep face clear of loaded rods. An improperly installed rod could release and cause facial injury or blindness.



No more than one person at a time. Multiple jumpers increase the chances of loss of control and collision and can result in serious head, neck, back, leg, arm or other injuries.



No somersaults or flips. Landing on the head or neck can cause serious injury, paralysis, or death, even when landing in the middle of the bed.



Never remove a net rod from its net rod pocket or disengage (unlock) the metal joiner while the net rod is under tension.



Do not hold onto, or place fingers between the rods while someone is jumping on the trampoline.



If you anticipate severe weather, consider lowering the enclosure, moving the trampoline to a sheltered location or disassembling the trampoline completely.



Entrapment and choking hazard possible for children under 6 years of age.



The Maximum User Weight for this trampoline is located on the front panel of this manual. Jumpers at or near the Maximum User Weight should take extra precautions in their manoeuvres to ensure they do not initiate contact with the ground while jumping as this can cause serious injury.

⚠ WARNING

Please read the following precautions carefully before beginning the assembly process. Retain for future reference.

- A. Two people are recommended for assembly.
- B. Keep small children at least 25 ft (7.5 m) away while assembling the trampoline; they could be injured by improperly assembled rods releasing and ejecting from the frame.
- C. Do not attempt to use the trampoline until it is completely assembled.
- D. Be aware that when loaded, the rods can spring back and may cause injury. Keep your face well clear of the rods during assembly or disassembly. An improperly installed rod could release and cause facial injury or blindness.
- E. The sleeves on the rods are intended to provide protection from fibers or splinters. Do not remove. If they are damaged, replace them.
- F. Maintain a minimum clearance of 16.5 ft (5 m) above the mat [in USA and Canada, 24 ft (7.3 m) above the trampoline from ground level] in order to prevent users from inadvertently contacting overhead hazards such as electric wires, tree limbs, clotheslines or ceilings.
- G. Maintain a minimum clearance of 5 ft (1.5 m) [in EU countries, 6.5 ft (2.0 m)] on all sides of the trampoline. This area should not include concrete, bitumen, brick or other hard surfaces or be in the proximity of other conflicting installations (e.g. pools, swings, slides, climbing frames) as these can cause serious injuries if users fall off the trampoline.

- H. Do not locate the trampoline on top of other objects or store anything underneath the trampoline bed.
- I. Place the trampoline in a well-lit area.
- J. Only use approved Springfree® Trampoline accessories, and install in accordance to installation instructions. Do not make modifications to the trampoline or accessories.
- K. Secure the trampoline against unauthorized and unsupervised use.
- L. The owner and supervisors of the trampoline are responsible to make all users aware of practices specified in the User Guide.
- M. Trampoline enclosure is supplied as part of the trampoline. Do not install enclosures that are not suited to your product.
- N. The trampoline is intended for indoor/outdoor usage. Refer to Trampoline location information in the User Guide for more details.
- O. Use only with mature, knowledgeable supervision. Enforce all safety rules.
- P. Record the purchase date of your trampoline on the net serial number tag. It is located under the net warnings, which are sewn into the edge of the net next to the entrance.

We encourage you to register your Springfree Trampoline. Doing so will create a customer profile which will allow us to provide future support and to send you important product notifications. <http://springfree.wclaim>

ASSEMBLY 1



Part	Quantity	Part	Quantity
A. Mat	1	D. Net Rods	10
B. Mat Rods	42	E. Spare C-clips	2
C. Net	1		

- Lay out the parts as shown.

ASSEMBLY 2

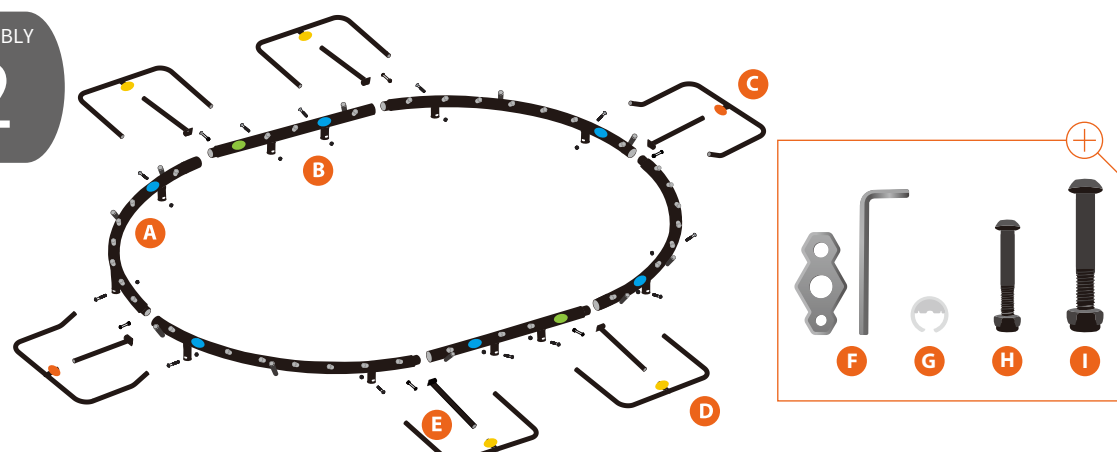

Part	Quantity	Part	Quantity
A. Curved Frame Sections	4	F. Tools	2
B. Straight Frame Sections	2	G. C-clips (Attached to Frame)	10
C. Bent Legs (Orange Sticker)	2	H. Small Bolts & Nuts	12
D. Legs (Yellow Sticker)	4	I. Large Bolts & Nuts	6
E. Center Posts	6		

- Lay out the remaining parts as shown. The colored stickers all face upwards.
- If you are missing any parts please contact Springfree Trampoline directly.

**WARNING** - Use the tools provided to fasten the nuts. Do not over tighten the nuts. The use of power tools may cause serious damage to the trampoline.

ASSEMBLY 3

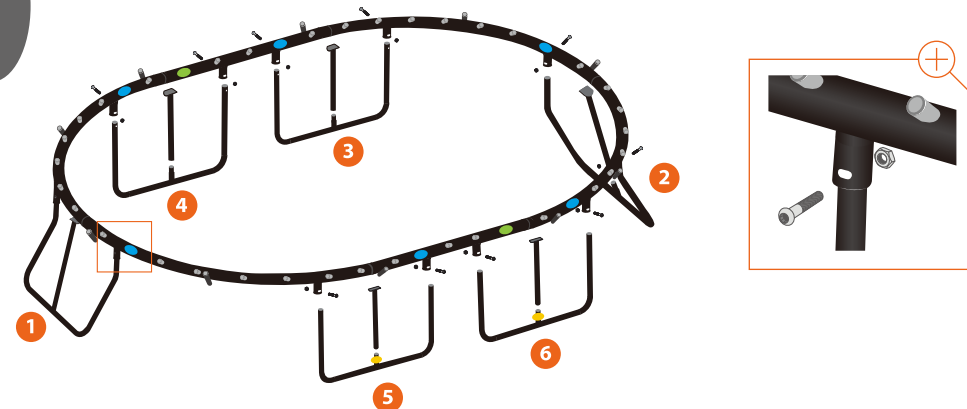

- Position the frame sections together.
- Connect and fasten frame sections using the large nuts and bolts. When finished, the bolt head should be flush with the frame and the nut should face the center of the trampoline.
- Attach a center post to the middle of each leg section.
- Then, in the order shown, carefully lift the frame and evenly insert the legs into the leg sockets on the underside of the frame.
- Fasten each leg to the frame using the small nuts and bolts before going to the next leg.

**TIP** - Fastening the final two frame sections often requires additional effort. Two people are required for assembly.  
**TIP** - When installing the legs, it is easiest when one person to holds the frame up and horizontal while the other person inserts the legs into the leg sockets.

ASSEMBLY 4

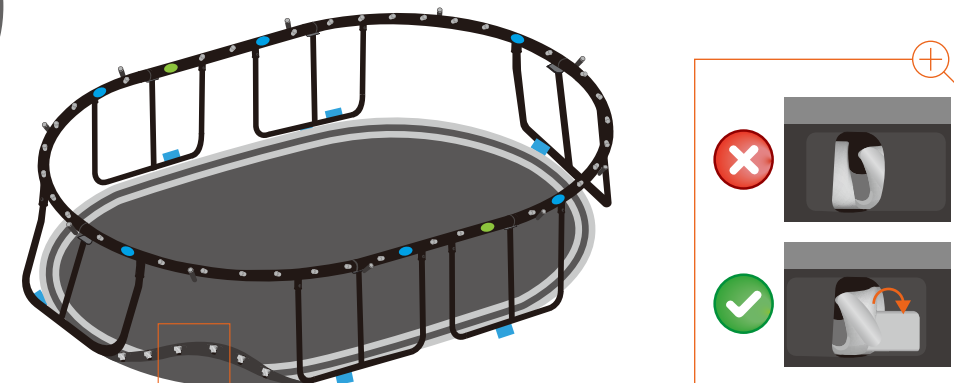

- Lay out the mat with the gray banding facing upwards inside the trampoline frame.
- The blue ■ tags on the mat should approximately align with the blue ● stickers on the frame.
- Before moving to the next step, ensure that the mat rod holders are correctly positioned with the mat rod holder tab outside the mat rod holder pocket, as per the insert. If the mat rod holder tab is inside the pocket, adjust accordingly.

ASSEMBLY 5

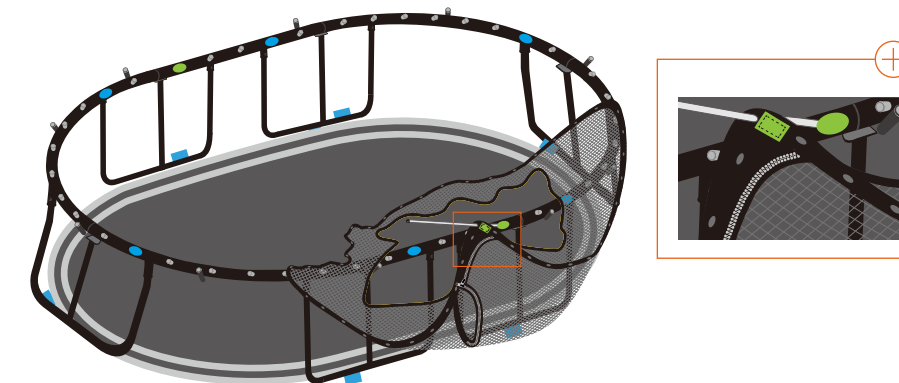

- Locate the green ■ tag on the bottom edge of the net and match it with any green ● sticker on your trampoline frame.
- Holding the net so that the green ■ tag is facing you, gently place the rest of the net inside the frame as shown. DO NOT let go of the green ■ tag.
- Put a mat rod through the hole to the immediate left of the green ■ tag in the net and then into the mat rod socket next to the green ● sticker.
- Then, working carefully around the frame, insert the remaining mat rods through the net holes and into the corresponding mat rod socket. When finished, the net should be stretched tightly around the OUTSIDE of the frame.
- Be sure that the mat rods are seated down to the bottom of each mat rod socket.

**NOTE** - As you install the mat rods into the mat rod sockets the net will become tight against the frame. Handle the net with care and be sure that it does not get caught or it may tear.  
**NOTE** - The net must be installed BEFORE installing the mat.

ASSEMBLY 6a ROD INSTALLATION TECHNIQUE

Please read before continuing. DO NOT INSTALL any of the mat rods yet.

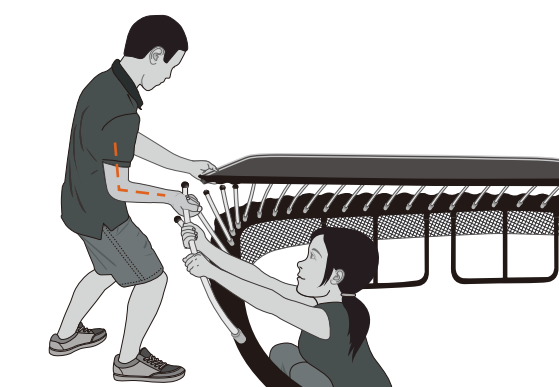

- Outside Person:**
  - Hold the mat rod near the ball end with your palm facing up and bend your arm at a right angle as shown.
  - Hold the mat edge with your other hand.
  - Pull your elbow into your hip and always push using your body weight.
- Inside Person:**
  - Hold the mat rod with both hands as shown to assist the outside person.

ASSEMBLY **6b** ROD INSTALLATION TECHNIQUE

Please read before continuing. DO NOT INSTALL any of the mat rods yet.

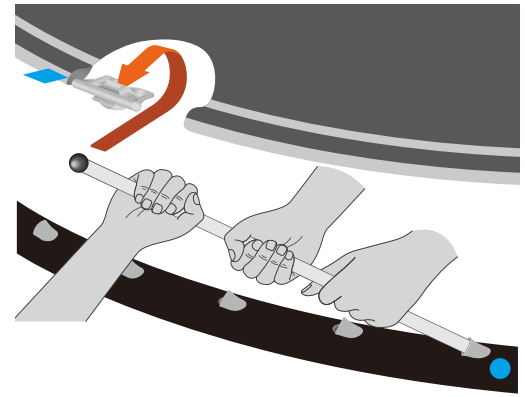

- Outside Person:**
- Push the mat rod, guiding the ball along the path shown, into the mat rod holder.
  - In one swift movement:
    1. Forward and under the mat rod holder.
    2. Up until the ball hits the mat underside.
    3. Back towards you, guiding the ball into the mat rod holder.
- Inside Person:**
- Pull the mat rod to assist the outside person in guiding the ball.
  - Maintain a steady grip until the ball is securely installed in the mat rod holder.

★ **TIP** - Keep the mat level when you install or uninstall the mat rods.  
 ★ **TIP** - If you need to uninstall a mat rod, see the Disassembly Instructions.

ASSEMBLY **10**

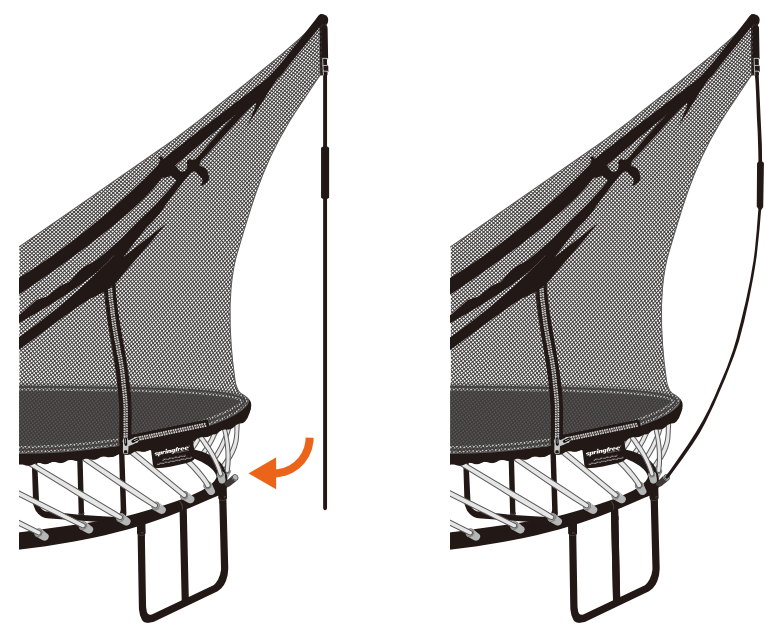

- To install the net, raise the net rods and carefully flex the bottom of the rods into the corresponding net rod socket on the trampoline frame. Take care to completely insert the net rod into the socket. You will hear a click when the net rod is fully seated.
- Ensure the sleeve does not slide down the net rod as this prevents the c-clip from engaging the groove at the bottom of the net rod.
- Congratulations! You have successfully installed your trampoline. Happy bouncing!

! **WARNING** - Never remove a net rod from its net rod pocket or disengage (unlock) the metal joiner while the net rod is under tension. First, remove the net rod from the net rod socket on the frame. Always ensure a solid grip when handling and do not stand directly in front of the rods.

★ **TIP** - For added safety, and stability, it is recommended to secure your trampoline to prevent displacement especially in areas of harsh weather conditions. Springfree Ground Anchors are available for purchase from [www.springfree.com](http://www.springfree.com).

ASSEMBLY **7a** FIRST ROD INSTALL

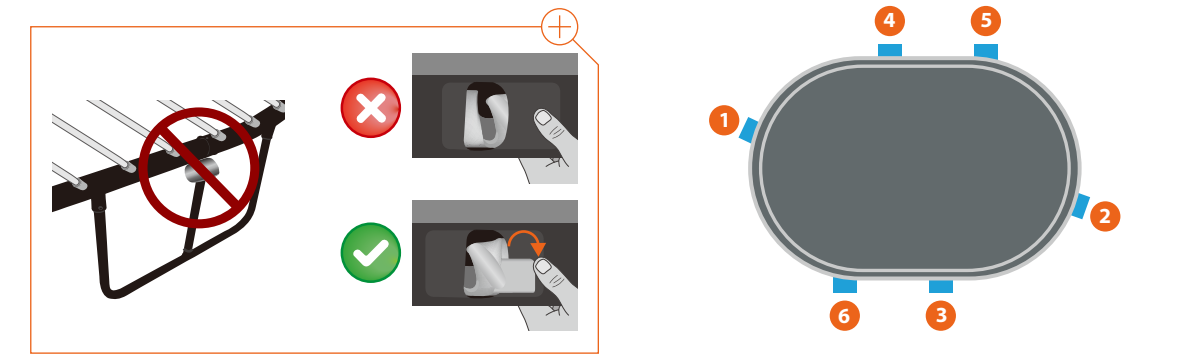

- Check that the center post of every leg is correctly seated under the trampoline frame. If they are not, adjust them now.
- Check every mat rod holder tab is outside the mat rod holder pocket.
- At position 1 find the blue sticker on the frame and the blue tag on the mat.
- Install the mat rod at the blue sticker location into the mat rod holder at the blue tag location.
- Repeat at position 2. Pulling the mat edge while pushing the mat rod will be required to install this second rod.
- Continue installing one rod at each of the remaining positions 3 4 5 6.
- Move to Step 7b.

! **WARNING** - Treat any loaded rod with caution until you are sure it is properly installed or uninstalled. Keep your face well away from any loaded rod.

STOP **NOTE** - Following the sequence shown spreads the tension evenly across the mat. If you do not follow this sequence, it will be very difficult to attach the mat.

ASSEMBLY **7b** REMAINING ROD INSTALL

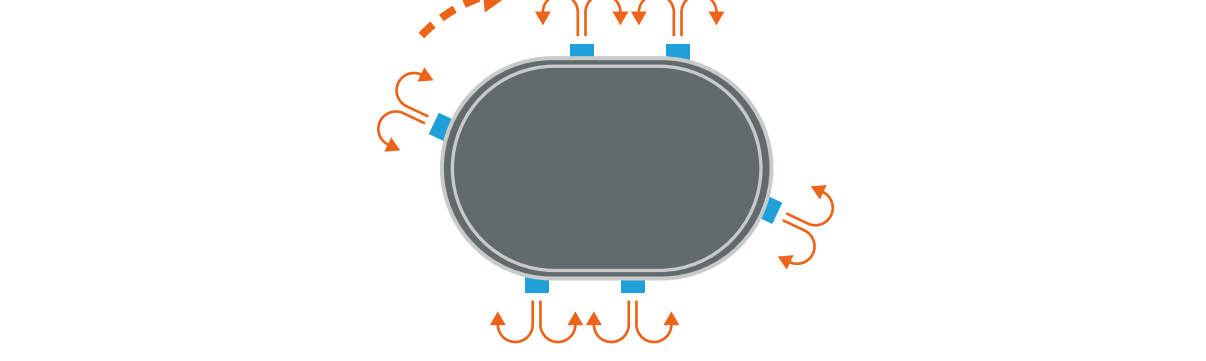

- Complete Step 7a before continuing.
- Start at any blue tag location and install two additional mat rods into the mat rod holders: one to the right and one to the left of the already installed mat rod.
- Move clockwise to the next blue tag location and repeat the above step.
- Continue clockwise installing two additional mat rods at every blue tag location, several times around the trampoline, until all of the rods are installed.

! **WARNING** - Treat any loaded rod with caution until you are sure it is properly installed or uninstalled. Keep your face well away from any loaded rod.

STOP **NOTE** - Following the sequence shown spreads the tension evenly across the mat. If you do not follow this sequence, it will be very difficult to attach the mat.

ASSEMBLY **8**

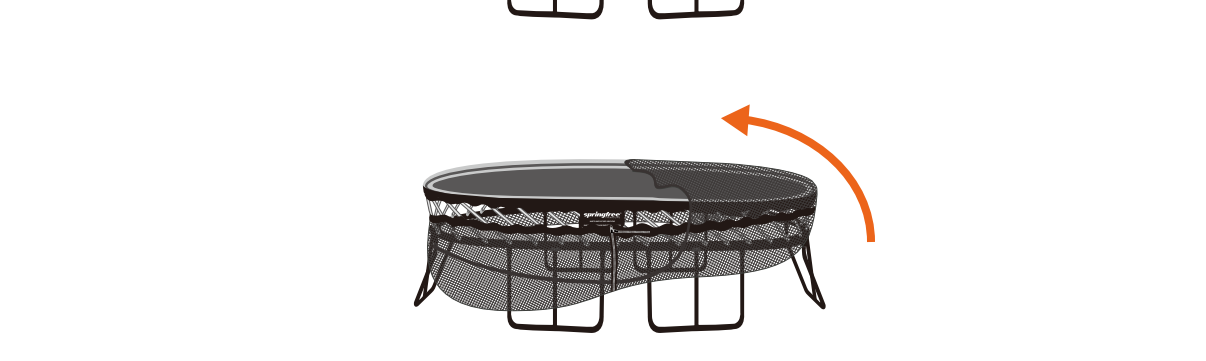

- Moving clockwise around the frame, carefully slide the net up to the top of the mat rods.
- Then, starting at one of the blue stickers on the curved frames, gently and slowly pull the net up and over the edge of the mat. It is normal for the net to be tight. Take extra care not to tug the net and check that the net is not snagged on the trampoline frame or the bolts.
- Working slowly around the frame, carefully lift the rest of the net over the edge of the mat until the bottom band of the net is pulled all the way to the top of the mat rods.

! **WARNING** - Do not use the trampoline until it is completely assembled. Failure to follow these instructions may cause rods to break or eject from the trampoline frame.

STOP **NOTE** - Check that the net is not caught on the trampoline frame or the bolts or under the legs; if the net catches, it may tear.

ASSEMBLY **9**

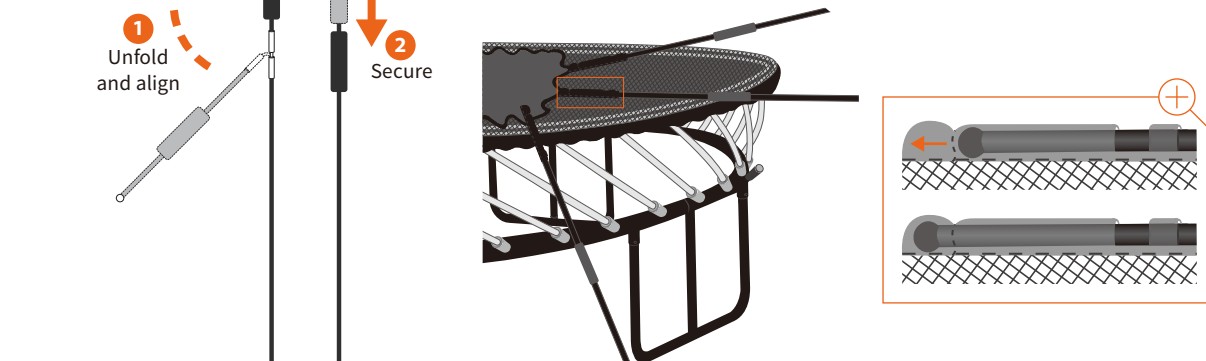

- Assemble the net rods as shown.
- Locate the pockets at the top edge of the net and install all of the net rods.
- Take care to fully push the ball of the net rod into the pocket as shown. There is an internal catch at the top of the pocket and the ball must be pushed past this internal catch or else it will come out. You will feel some resistance as the ball is pushed through.

! **WARNING** - Treat any loaded rod with caution until you are sure it is properly installed or uninstalled. Keep your face well away from any loaded rod.

STOP **NOTE** - If you purchased a FlexrHoop™ with your trampoline, you could stop and install it right now. This will save you a couple of steps later.

DISASSEMBLY **2a** ROD REMOVAL TECHNIQUE

Please read before continuing. Do not remove any of the mat rods yet.

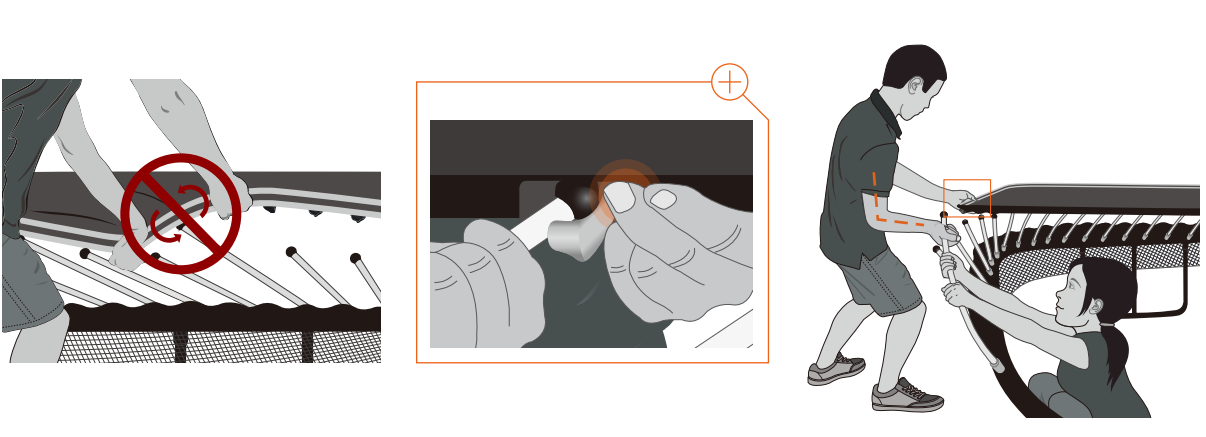

- Outside Person:**
- When you remove a rod from the mat, do not twist or rotate the mat edge. This could cause serious injury or damage the trampoline.
  - Hold the mat edge flat with your left hand as shown. Push up behind the mat rod holder tab without obstructing the opening. This prevents the ball from catching in the mat.
  - Hold the mat rod near the ball end with your palm facing up and bend your arm at a right angle as shown.
  - Pull your elbow into your hip and always push using your body weight.
- Inside Person:**
- Hold the mat rod with both hands as shown to assist the outside person.

! **WARNING** - Treat any loaded rod with caution until you are sure it is properly installed or uninstalled. Keep your face well away from any loaded rod.

DISASSEMBLY **2b** ROD REMOVAL TECHNIQUE

Please read before continuing. Do not remove any of the mat rods yet.

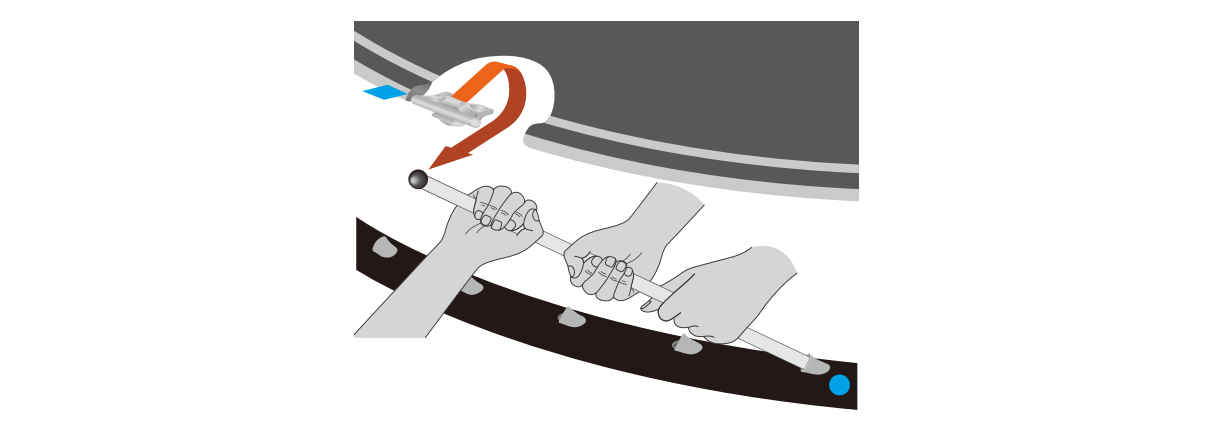

- Outside Person:**
- Push the mat rod out of the mat rod holder, guiding the ball along the path shown.
  - In one swift movement:
    1. Up and forward into the mat underside, out of the mat rod holder.
    2. Down and away from the mat underside.
    3. Back towards you, easing it to a resting position.
- Inside Person:**
- Pull the mat rod to assist the outside person in guiding the ball up and out of the mat rod holder.
  - Maintain a steady grip until the ball is securely removed from the mat rod holder.

! **WARNING** - Treat any loaded rod with caution until you are sure it is properly installed or uninstalled. Keep your face well away from any loaded rod.  
 ! **WARNING** - Both people must maintain a steady grip on the rod until it is in its resting position.

DISASSEMBLY **3** MAT ROD REMOVAL

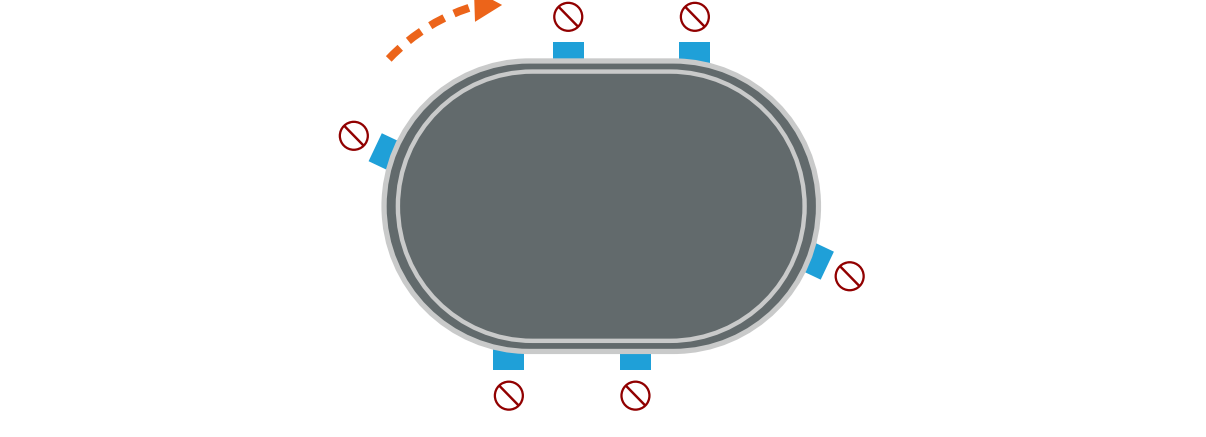

- Moving clockwise between the blue tag locations, remove every other installed mat rod (remove one, skip one). Do NOT remove the mat rods at the blue tag locations.
- Repeat the above step (removing every other installed mat rod), several times around the trampoline, until only the mat rods at the blue tag locations remain.
- Continue clockwise removing the final mat rods at each of the blue tag locations. Pulling the mat edge while pushing the rod will be required to uninstall these rods.
- Remove the mat rods from the frame and then pack the net, mat and rods.
- Disassemble the frame in the reverse order to which it was assembled.

! **WARNING** - Treat any loaded rod with caution until you are sure it is properly installed or uninstalled. Keep your face well away from any loaded rod.

STOP **NOTE** - Following the sequence shown maintains the tension evenly across the mat. If you do not follow this sequence, it will be very difficult to remove the mat.